



Cleaning Solutions & Services



Elix Clean Cleaning Cards for Cash and Credit Card Automated Systems

- Automatic teller machines (ATMs)
- Electronic funds transfer (ETF) terminals
- Bank note acceptors (BNA's)
- Car park ticket machines
- Petrol station payment points
- Automated ticketing and boarding (ATB) systems
- Food and drinks vending machines
- Ticket vending machines
- Security access systems
- Card-operated telephones
- Games machines
- Cigarette vending machines



For all cash and credit card automated systems.



Elix Clean Cleaning Cards – for all types of automated systems currently available.

Elix Clean Cleaning Cards clean all conventional cash and credit card automated systems. The card sizes correspond to international standards for the installations.



For complete care of automated systems.

- Cleaning cards
- Surface cleaner for metal, plastic, glass
- Roller cleaner
- Electronics cleaner
- Aerosols
- Cleaning tissues
- Accessories such as brushes, tweezers, swabs



Our competencies:

- We develop first class cleaning cards and cleaning agents for all card readers and bank note acceptors.
- We are experts in current automated machine technology.
- With over 20 years of experience, ECS is one of the pioneers of automated system cleaning.
- ECS is certified under ISO 9001:2000.

Our product: Elix Clean

- Elix Clean Cleaning Cards for all cash and credit card automated systems (with and without access control, insertion reader and swipe reader),
- Elix Clean Banknote Tissues for all conventional BNAs,
- Elix Clean Cleaning Tissues for ATB printers,
- Elix Clean Cleaning Sets for complete internal and external cleaning of automated systems,
- Elix Clean Surface Cleaning for metal glass and plastic,
- Elix Clean Accessories such as brushes, swabs and tissues
- Elix Clean Technician Set

Our service:

- We develop cleaning cards to meet customer specific requirements.
- Private label: You can receive ECS products with your own company specifications.
- Technical advice: We advise you in the choice of cleaning system and help you to evaluate solutions.

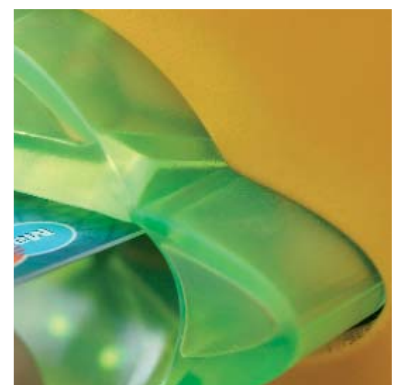
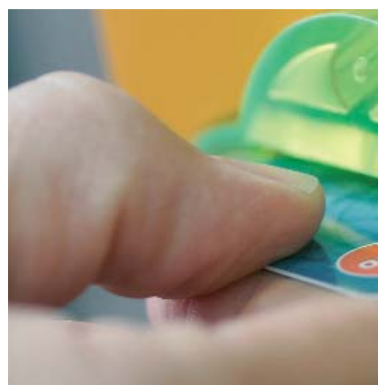

Trouble-free automated systems – satisfied customers.



Elix Clean Cleaning Card comes in a handy moist pouch: Taking care of the automated machine can be so easy – tear open the pouch and insert the cleaning card.



Elix Clean Cleaning Cards Set: The dry cards are moistened with magnetic head cleaner.

Over 90% of all ATM break-downs are due to the machine being dirty. The most persistent enemy of sensitive card readers and bill testers is the daily dirt accumulated through grease, sweat, dust and electrical smog. Elix Clean Cleaning Cards from ECS help against this:

→ **Regular maintenance cleaning protects your installations in the long term from breakdowns and faults. And it protects you from unpleasant service costs and a loss in sales.**

Effortless cleaning. Elix Clean Cleaning Cards are simple to use: Insert a moist card once a week and swipe it two or three times – done!

Consistent moist cleaning.

The ECS philosophy for the cleaning of automated systems is the use of moist cleaning. This way, persistent deposits on card readers and bill testers such as dermafat and nicotine can be thoroughly removed. For gentle moist cleaning the cleaning cards are soaked in high-purity solvents.



Elix Clean Fleece: Good value cleaning. Cellulose fleece, tried and tested over many years, is effective thanks to its perfect cleaning effect. The conventionally processed surface of the fleece card captivates with its unique value for money.



Elix Clean Flock: Efficient cleaning thanks to its brushing effect. A very efficient cleaning effect is achieved by means of the fine and long bristles. The flock coating guarantees a very high uptake of dirt.

For all card readers and bank note acceptors.



Card readers with access control

Coded cleaning cards for ATMs with shutter

- Bank cash dispenser
- Post office cash dispenser
- Bank information terminal

Insertion and swipe readers

Cleaning cards for automated systems with swipe reader, mechanical insertion reader or reader with motor but without shutter.

- Payment terminal (EFT)
- Petrol station payment point
- Food and drinks vending machines
- Ticket vending machine
- Security access system
- Card-operated telephone
- Games machines
- Cigarette vending machines

Bank note acceptors

The banknote tissues are available in all requested note sizes (CHF, Euro, Dollar, etc.).

- Car park ticket machine
- Petrol station payment point
- Ticket vending machines

Automated ticketing and boarding systems

Cleaning tissues for the cleaning of reader head and collection shaft for ATB printers

- Tickets and boarding passes
- ATB printers

Complete cleaning of machine: The 'all in one' Elix Clean Cleaning Set contains everything that is needed for the professional cleaning of automated systems, from the cleaning card to the casing cleaner and the surface tissue.



Excellent cleaning thanks to the brushing effect.

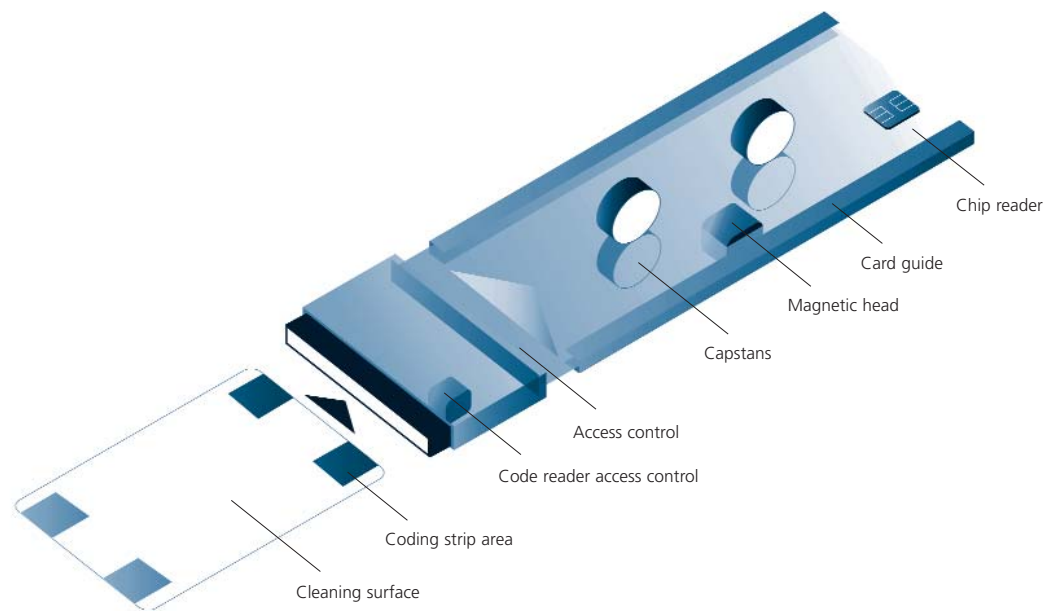

Effective cleaning thanks to the brushing effect. The excellent uptake of dirt of the flock prevents the overall distribution of dirt in the interior of the card reader. The particles attach to the fibres and are therefore removed together with the card. The flock cards are used together with high-purity Elix Clean solvent.

Clean Contact. A smooth processing of a card is ensured when the data transfer to the magnetic head and chip contact functions without fault. Elix Clean Cleaning Cards make sure that these functions are fulfilled fully and reliably.

Coded magnetic strips. Elix Clean Cleaning Cards for bank and post office cash dispensers are fitted with a coded magnetic strip. Like a bank or credit card, this strip opens the access control (shutter) when inserting the card into the cash machine.

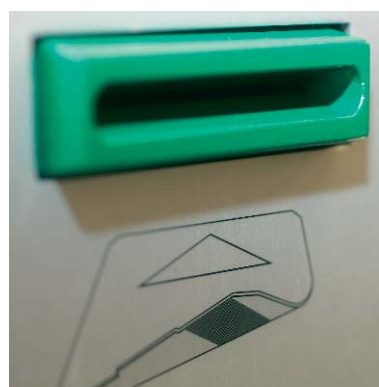
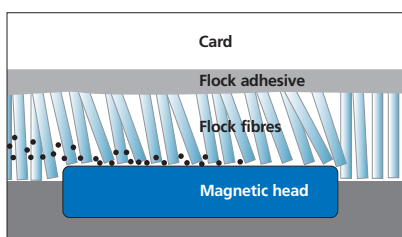

Passing the test: The Elix Clean Flock Card.



The flocked, moist Elix Clean Cleaning Cards pass the test with flying colours.

Testing by Sulzer Innotec.

The renowned company Sulzer Innotec tested Elix Clean cards alongside conventional cleaning cards. The test results clearly show that the damp, flock-coated Elix Clean Cards achieved better results than conventional cards. This is due to the effective brushing effect of the Elix Clean Flock Card in combination with the Elix Clean Cleaning Solution. Conventional cards that are produced more cheaply were the least effective.

The coating makes the difference.

In the development of the Cleaning Cards we are focussing on the most important thing: the card surface. The specially processed coatings are responsible for the high quality cleaning effect on the magnetic head, chip contact and capstans.

Elix Clean Cleaning Cards are coated with either flock or fleece. The thickness, length and absorptive capacity of the fibres decide on the cleaning effect of the cards. In this regard, both coatings show exceptional characteristics. A direct comparison favours the flock coating, the more expensive to produce of the two.

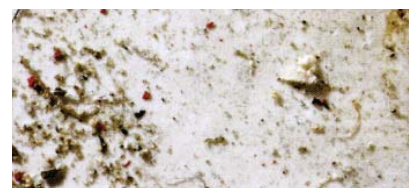

Dirty magnetic head

Dirt such as sand, fat, sweat, colour pigments and fibres prevent 100% effectiveness of the reading from the magnetic head (scale 22:1). Picture: Sulzer Innotec

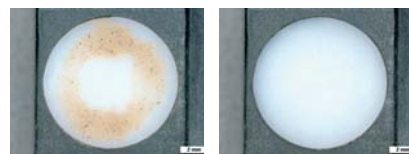

Cleaning effect in testing

This is how the flocked Elix Clean Cleaning Card works: The deposits on the reading head disappear without a trace (picture right). Picture: Sulzer Innotec





ECS AG – Your Partner for cleaning of automated systems

With our superior cleaning systems for regular cleaning of card readers and bill testers we have extensive expertise in this field. For over 20 years we have been developing cleaning cards and solutions for all types of systems used.



ECS

■ SWITZERLAND
 ECS AG
 Roosstrasse 53
 PO Box
 8832 Wollerau
 Switzerland
info@ecsag.com
www.ecsag.com
 Tel. 0041 44 787 53 53
 Fax 0041 44 787 53 63

■ GERMANY
 ECS Cleaning Solutions GmbH
 Storkower Straße 132
 D-10407 Berlin
 Germany
grossherr@ecsag.com
www.elixclean.com
 Tel. 0049 30 364 640 36
 Fax 0049 30 364 640 34

Contact us.

Are you looking for a cleaning system for automated systems or office appliances? Then contact us. We have the solution that will suit you perfectly.

Order online.

At www.elixclean.com you will find a selection of over 500 articles for the professional cleaning of automated systems and office appliances. From cleaning cards for automated systems to cleaning swabs for computer keyboards.

DISTRIBUTORS

■ BRAZIL
 Kapatron Informatica –
 Instalações – Parking
 Av. Guilherme Dumont Vilares,
 1715 – Cj.3A – Morumbi
 Sao-Paulo – SP 05640-003
 Brazil
cbufano@kapatron.com.br
 Tel. 0055 11 3746 0239

■ UNITED KINGDOM, IRELAND
 Electromech ECS Limited
 Unit 40 Portland Court
 Kingsway
 Luton Bedfordshire LU4 8HA
 United Kingdom
sales@electromech.co.uk
 Tel. 0044 1582 483 322
 Fax 0044 1582 404 416

■ HUNGARY
 EURO-LINE 2000 Kft.
 Széchenyi utca 2
 2100 Gödöllő
 Hungary
info@elixclean.hu
 Tel. 0036 30 450 3164
 Fax 0036 28 418 824

■ KOSOVO MACEDONIA,
 ALBANIA, CROATIA
 N.T.P.SH. «JAKUPI»
 B.Diell Zon. Jug. Obj.1. LLAM 11 LOK=3
 10000 Prishtina
 Kosovo
europaketim@yahoo.com
 Tel. 00377 44 600 580
 00377 44 600 501
 Fax 00381 38 544 818